

TS3 Series

VarTech's industrial-grade, gasket sealed ToughStation series of monitors and computers are available in 10.4" to 43" screen sizes and constructed of 316 stainless steel or powder coated aluminum.

The rugged display's fully sealed enclosure is corrosion and moisture resistant for use in work environments that require frequent washdowns and chemical sanitation. Shock and vibration resilient components and harnessed cables reduce strain on internal parts yielding additional ruggedness to the overall design.

This series is available with several powerful embedded computer options for continuous use in demanding HMI processes throughout many industrial applications.



TS3 series standard in black powder coated aluminum or stainless steel. Custom colored powder coating available.

Standard Features:

- Industrial-grade LED back-lit LCD
- Power input: 12 VDC, 9-36 VDC, or 90-264 VAC internal power supply
- Mounting configurations: VESA or standard RAM. Optional mounts available by request: panel with studs, console, console extreme, mounting tabs and pedestal
- Available touchscreens: resistive, PCAP, and ArmorTouch
- Operating temperature: -10° to 60° C (Extreme Temperature Package available depending on size. Please inquire.)
- Relative humidity: ≤ 90% to ≤ 95% (depending on mechanical build)
- Altitude: 10,000 ft MSL
- 2-year warranty

Computer Features:

- Embedded computer
- Operating system: Windows 10 Professional 64-bit (standard)
- 2 × 10/100/1000 Mbps LAN

Monitor Only Features:

- On Screen Display (OSD) controls

Dimensions (W × H × D) and Specification Chart:

Size	VESA/RAM & Mounting Tab Dimensions** ***	Panel/Console & Console Extreme Dimensions**	Brightness	Resolution	Touchscreen†	Viewing Angle	Contrast	Aspect Ratio	Power Consumption (Calculated at 12 V DC)	Approx. Weight‡ § (Stainless Steel)	Approx. Weight‡ § (Aluminum)	Maximum I/O Ports Avail. (Including Power)
10.4"	12" × 9.75" × 3.28"	13.98" × 11.73" × 3.28"	400 nits 1300 nits☀	SVGA 800 × 600 XGA 1024 × 768	Res/PCAP/AT	80°/80°/80°/80° 80°/80°/65°/65°	1000:1 700:1	4:3	≈ 11 W ≈ 24 W	≈ 12.9 Lbs	≈ 9.9 Lbs	5
12.1"	13" × 10.75" × 3.28"	14.98" × 12.73" × 3.28"	400 nits 1200 nits☀	XGA 1024 × 768 XGA 1024 × 768	Res/PCAP	85°/85°/85°/85° 85°/85°/85°/85°	750:1 750:1	4:3	≈ 9 W ≈ 22 W	≈ 13.9 Lbs	≈ 11.9 Lbs	6
12.1" wide	13.76" × 10.15" × 3.28"	15.74" × 12.13" × 3.28"	500 nits 1500 nits☀	WXGA 1280 × 800 WXGA 1280 × 800	Res	85°/85°/85°/85° 80°/80°/80°/60°	750:1 700:1	16:10	≈ 17 W ≈ 34 W	≈ 14.9 Lbs	≈ 12.9 Lbs	
15"	15.38" × 12.38" × 3.19"	17.36" × 14.36" × 3.19"	400 nits 1500 nits☀	XGA 1024 × 768 XGA 1024 × 768	Res/PCAP/AT	80°/80°/80°/80° 80°/80°/60°/80°	600:1 800:1	4:3	≈ 12 W ≈ 47 W	≈ 17.15 Lbs	≈ 12.9 Lbs	7
15.6"	16.86" × 11.11" × 3.25"	NA	400 nits 1500 nits☀	FHD 1920 × 1080 FHD 1920 × 1080	Res/PCAP/AT	80°/80°/70°/70° 88°/88°/88°/88°	700:1 750:1	16:9	≈ 16 W ≈ 49 W	≈ 16 Lbs	≈ 11 Lbs	
17"	17" × 14.5" × 3.21"	18.98" × 16.48" × 3.21"	350 nits 1000 nits☀	SXGA 1280 × 1024 SXGA 1280 × 1024	Res/PCAP/AT	80°/80°/60°/80° 80°/80°/60°/80°	800:1 1000:1	5:4	≈ 25 W ≈ 62 W	≈ 17.9 Lbs	≈ 13.9 Lbs	7
19"	18.5" × 15.38" × 3.19"	20.48" × 17.36" × 3.19"	350 nits 1600 nits☀	SXGA 1280 × 1024 SXGA 1280 × 1024	Res/PCAP/AT	85°/85°/80°/80° 85°/85°/80°/80°	1000:1 1000:1	5:4	≈ 20 W ≈ 60 W	≈ 19.9 Lbs	≈ 14.9 Lbs	
21.5" wide*	22.02" × 14" × 3.53"	23.99" × 15.98" × 3.53"	300 nits 1500 nits☀	FHD 1920 × 1080 FHD 1920 × 1080	Res/PCAP/AT	89°/89°/89°/89° 89°/89°/89°/89°	5000:1 1000:1	16:9	≈ 24 W ≈ 42 W	≈ 25 Lbs	≈ 20 Lbs	7
24" wide*	24.43" × 15.52" × 2.90"	26.41" × 17.5" × 2.9"	300 nits 1500 nits☀	FHD 1920 × 1080 FHD 1920 × 1080	PCAP/AT	89°/89°/89°/89° 89°/89°/89°/89°	5000:1 1000:1	16:9	≈ 9 W ≈ 34 W	≈ 27 Lbs	≈ 22 Lbs	
32" wide*	31.34" × 19.51" × 3.9"	33.32" × 21.49" × 3.9"	500 nits 1500 nits☀	FHD 1920 × 1080 FHD 1920 × 1080	PCAP	89°/89°/89°/89° 89°/89°/89°/89°	3000:1 4000:1	16:9	≈ 10 W ≈ 126 W	≈ 54.9 Lbs	≈ 44.9 Lbs	7
43" wide*	41.38" × 25" × 3.57"	NA	500 nits 1500 nits☀	FHD 1920 × 1080 FHD 1920 × 1080	NA	89°/89°/89°/89° 89°/89°/89°/89°	3000:1 4000:1	16:9	≈ 66 W ≈ 155 W	≈ 70 Lbs	≈ 57 Lbs	

☀ Sunlight readable LCD

* Available in swing arm mount

** For solutions with heat sink, add 1.062" to depth (D)

*** Mounting tabs add 2" to height, 32" & 43" adds 2.5" to height

† Res - resistive touch, PCAP - projective capacitive touch, and AT - ArmorTouch glass-on-film resistive touch

‡ Weight may differ based on overall configuration

§ Heatsink adds approximately 4 Lbs

LCD Controller Board Specifications:

Option	Resolution	Available Video I/O Ports	Horizontal/Vertical Scan
A*	Up to 1440 × 900, 8-bit	1 × DVI, 1 × VGA	60 Hz up to 1440 × 900
B*	Up to 1600 × 1200, 8-bit	1 × DVI, 1 × VGA, 1 × Composite (PAL/NTSC)	60 Hz up to 1600 × 1200
C	Up to 1920 × 1200, 8-bit	1 × HDMI, 1 × Display Port, 1 × VGA	60 Hz up to 1920 × 1200
D	Up to 1920 × 1200, 10-bit	1 × HDMI, 1 × DVI, 1 × VGA 1 × Composite (PAL/NTSC)	60 Hz up to 1920 × 1200

Non-standard controller boards and I/O ports available depending on panel size. Please inquire.
* Not compatible with FHD screen resolution

Standard Motherboard Specifications:

Option	Processor	Memory	Storage Drive	Operating System	Available I/O Ports
E*	Intel Atom E3845	Up to 8 GB	1 × SATA-300 1 × CFAST	Win 7: 32/64-bit, Win 10: 32/64-bit	2 × RS-232/422/485 3 × USB 2.0 1 × LAN
F*	Intel J1900 Quad-Core	Up to 8 GB	1 × SATA-300 1 × CFAST	Win 7: 32/64-bit, Win 10: 32/64-bit	2 × RS-232/422/485 3 × USB 2.0 1 × LAN
G*	i5-7300U	Up to 16 GB	1 × SATA-300 1 × mSATA/SIM	Win 10: 64-bit	2 × RS-232/422/485 4 × USB 3.0 2 × LAN
H	Celeron G3900TE, i3-6100TE, i5-6500TE, i7-6700TE	Up to 32 GB	1 × SATA-600	Win 10: 64-bit	1 × RS-232/422/485 3 × USB 3.0 1 × USB 2.0 2 × LAN

Non-standard motherboards and processors available depending on panel size. Please inquire.
Motherboard selection may affect operational temperature
* Fanless operation available

Available Options:

- Dimming: Manual dimmer dial – 1000:1 dimming ratio, or auto-dimming
- Optical bonding (VBOND): adhering a cover glass, protective overlay, or touchscreen to the front surface of the LCD using an optical-grade silicone to increase solar reflectivity and ruggedness.
- Private labeling: company logo or corporate identity for OEM/VAR applications
- Coatings: custom powder coats, paint, and chemical resistant finishes
- Internal conformal coating: protection from moisture, dust, and corrosion
- Fanless design: solid-state components
- Available accessories: glare protection hood, keyboard bracket

Computer Options:

- 1 × VGA, 1 × HDMI
- Operating system: Windows 10 Professional – 32 & 64-bit, Windows 10 Enterprise, Windows 7 – 32 & 64-bit, Linux (select versions of Linux supported)
- Additional and/or alternate I/O ports available: Please contact your sales representative
- Storage: HDD, SSD, removable drives, various capacities, multiple drives
- Expansions: PCI, PCIe, mPCIe, M.2, SIM card slot
- ThinManager® thin client management
- Wireless connectivity: Bluetooth, WiFi, integrated router/WiFi repeater

Monitor Only Options:

- OSD button placement: OSD membrane control buttons can be mounted in alternate locations on front or rear of the display (front mounting options not available on all mechanical designs), or wired remote OSD
- OSD options: Bluetooth control, IR remote, programmable hotkeys, RS-232 OSD control (PC APP or serial commands)
- Display options: USB failover, PIP
- Audio pass-through
- Integrated KVM extender
- Legacy video support: 15 kHz to 30 kHz, and SOG/composite/separate horizontal and vertical sync

Environmental Functional Upgrade Packages available. See next page.

Standard I/O Connectors: bottom or rear exit connectors

Sealed IP68: general purpose connector for ToughStation fully sealed series

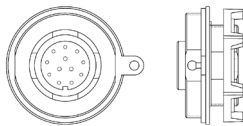

Gland rated up to IP69K: standard sealed captive I/O cables for our hazardous area series

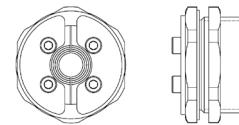

Available Ruggedized I/O Connectors:

M8/M12/M23: industrial automation, vibration and shock-resistant

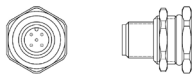

MIL-DTL 38999: military standard, sealed, vibration and shock-resistant quick-coupling circular locking connectors

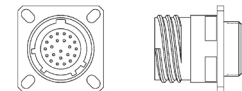

Mounting Option Examples:

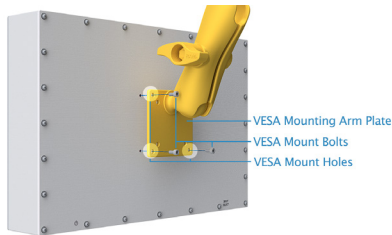

VESA or standard RAM

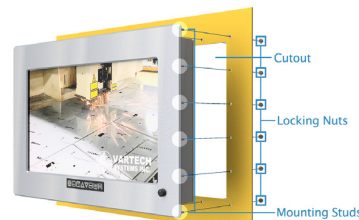

Panel with studs

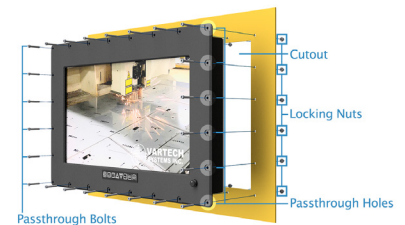

Console and console extreme

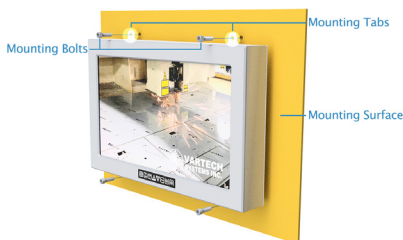

Mounting Tabs

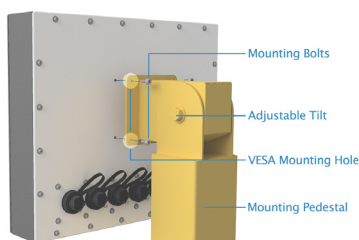

Pedestal (optional pedestal designs avail. please inquire.)

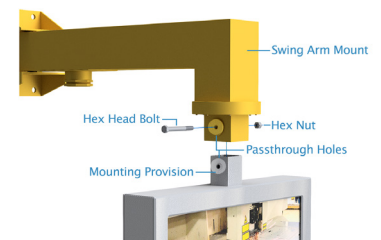

Swing arm/swivel



Environmental Functional Upgrade Packages:

VarTech's Environmental Functional Upgrade Packages allow for custom COTS solutions using standard feature sets.

High Bright Sunlight Readable Package	Component Ruggedization Package	Extreme Temperature Package (-40° C to 70° C)
<ul style="list-style-type: none"> High luminance LED backlights Proprietary optical film stack Optical bonding of protective window or touchscreen to LCD Anti-reflective coatings Brightness levels ranging from 700 nits to 1500 nits (depending on screen size) Dimming: Manual dimmer dial – 1000:1 dimming ratio, or auto-dimming Optional: backlight kill switch 	<ul style="list-style-type: none"> Shock/Vibration resistance: video controller board or motherboard, cable assemblies/connectors Potted components where applicable Vibration dampening Optical bonding of protective window or touchscreen to LCD MIL-DTL 38999 I/O connectors (not available on hazardous area models) <p>Designed to meet tolerances specified by select subcategories of MIL-STD 810F and/or DEFSTAN 00-35 inclusive of Part 3 Issue 4.</p>	<ul style="list-style-type: none"> Integrated heater and thermostat Wide temperature LCD panel Harsh environment video controller board or motherboard/SSD/RAM Optional: heat-reflective powder coat Optional: uninterrupted wide temperature dual Power Supply Unit (PSU) system
EMI/EMC 461 AS Package	Field Serviceable Peripheral Compartment	Vandal/Impact Resistant Package
<ul style="list-style-type: none"> All-Surface ingress protection and Faraday cage design Protective window or touchscreen equipped with 8 Ohm ITO for surface ship limits and 100 OPI SSTL mesh or 160 OPI copper printed mesh for Army ground limits Enhanced EMI conductive gaskets for MIL-STD 461 protection while maintaining seal up to IP67 MIL-DTL 38999 connectors with backshell assembly Cable braiding, ferrites, and in-line bandpass filters where applicable CE101, CE102, CS101, CS106, CS114, CS115, CS116, RE101, RE102, RS101, RS103 (Designed to meet based on similar VarTech Systems Designs) Optional: Mil-STD 1275 	<ul style="list-style-type: none"> Maintains IP65/PI66 enclosure rating Auxiliary DC power terminal block (available voltage/amperage varies with design) Exterior I/O connectors can be routed to the sealed compartment Allows for aftermarket support of KVMs, video amplifiers, SFF PCs, storage drives 	<ul style="list-style-type: none"> Impact resistant protective overlay glass 8H abrasion-resistant overlay glass Chemical and stain resistant glass and surfaces Tamper-proof conduit connectors Optional: PCAP touchscreen

ToughStation Core Model Number Breakdown:

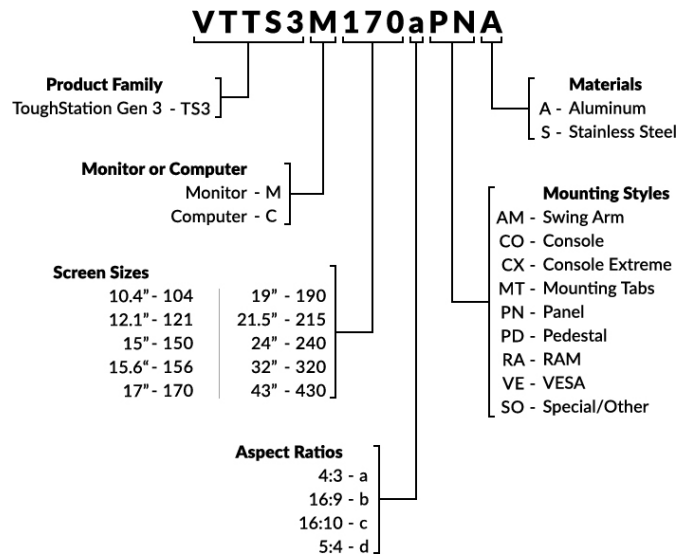

Over 30 Years of Rugged HMI and Industrial Computer Manufacturing Experience

